

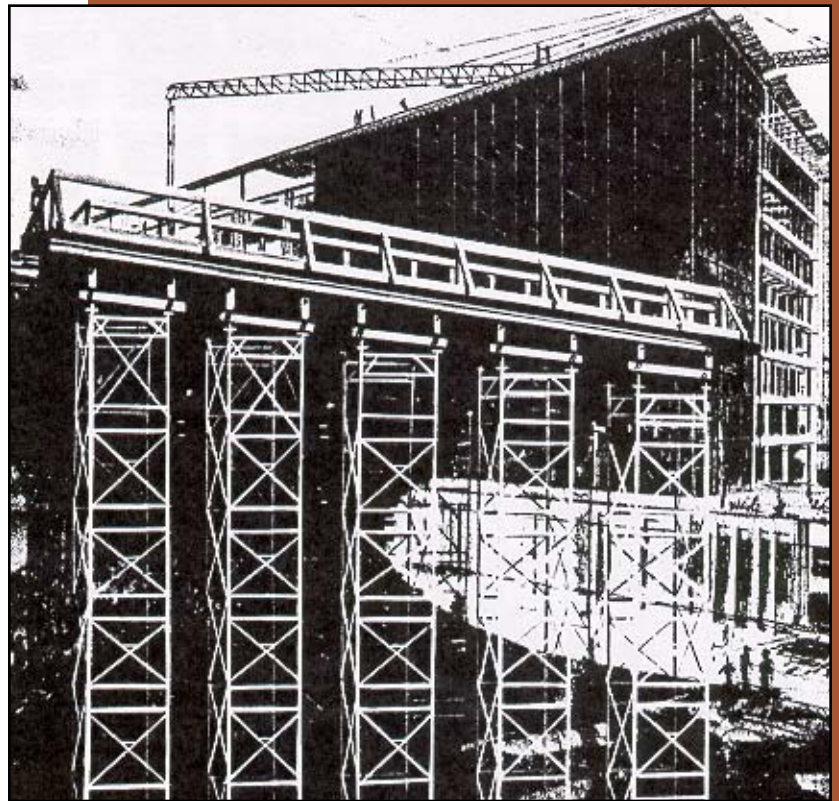

Shore "X" Higher Capacity And Unique Extension Frames Can Cut Costs

- Fewer towers needed
- Fewer types and sizes of components
- Reduces erection costs
- Lower stripping costs
- Reduces cartage costs

SHORE "X" HEAVY DUTY SHORING



SHORE "X"

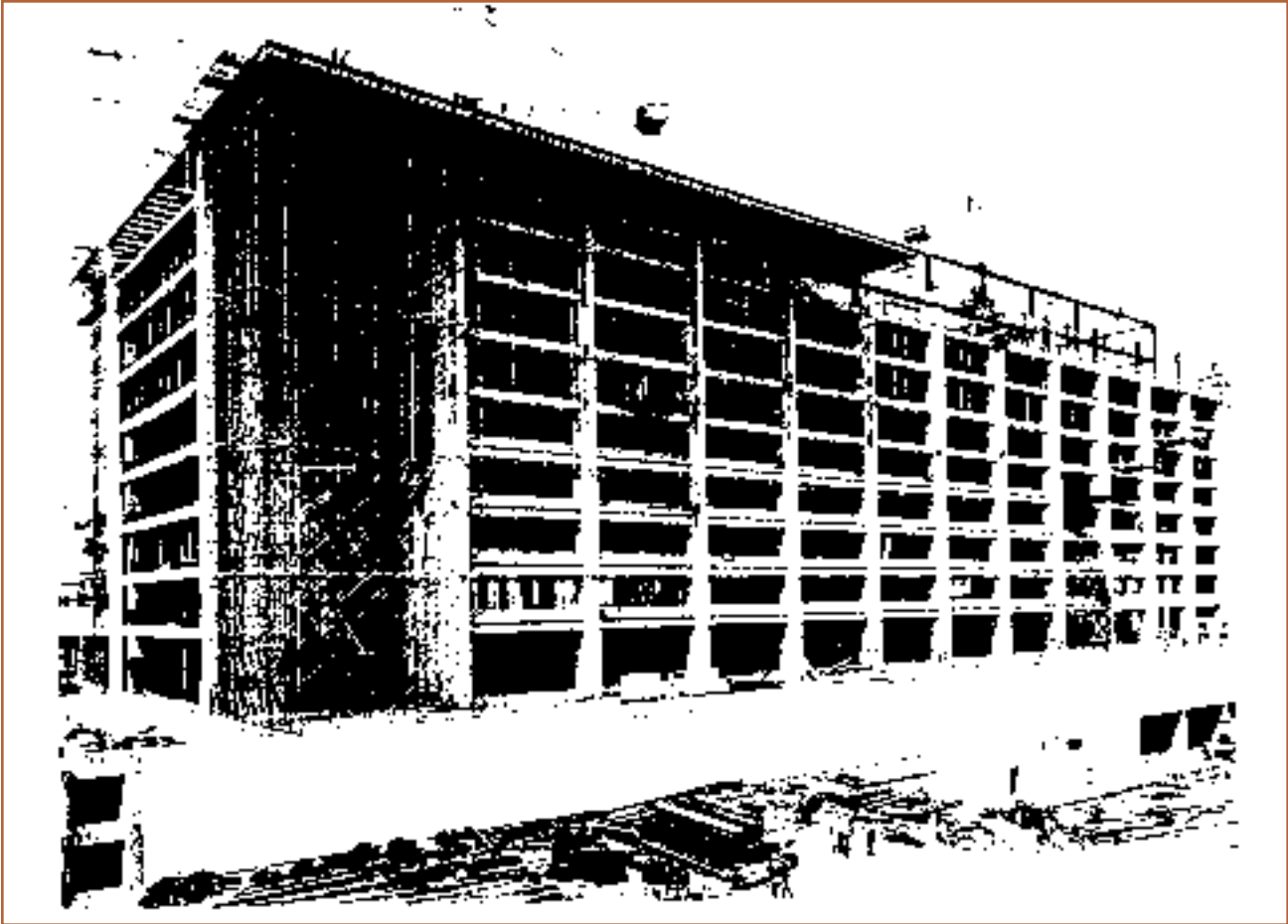

Office Building

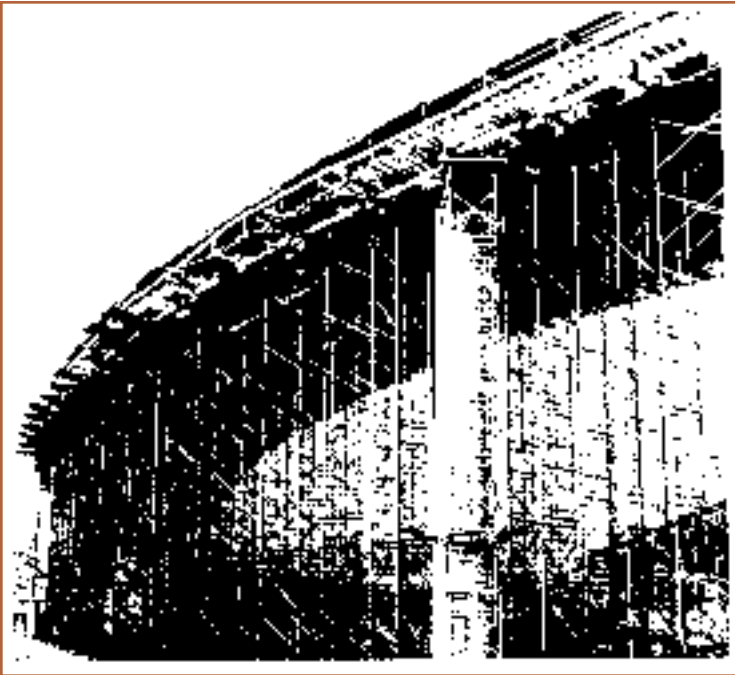

Highway Bridge

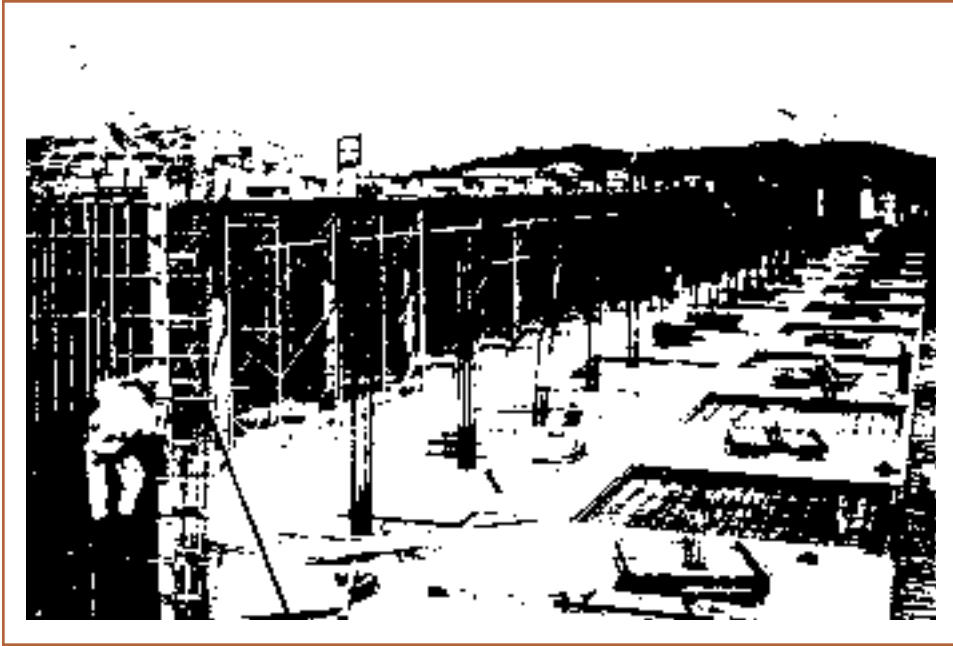

Metropolitan Water District Reservoir

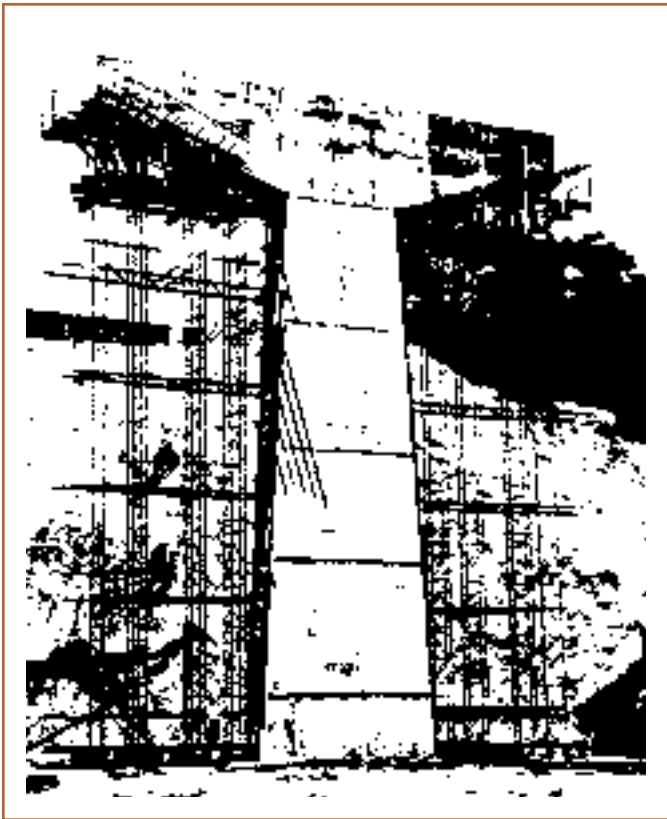

Bridge Bent Cap

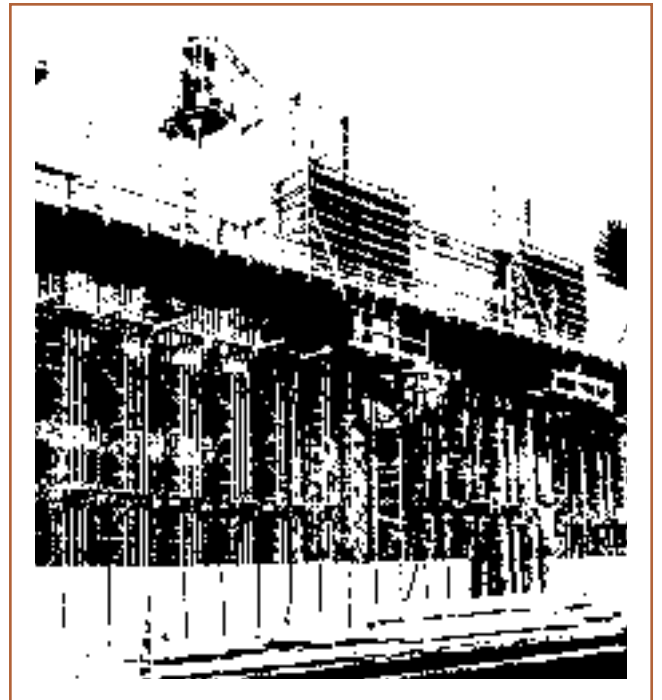

Office Building

SHORE “X”

Shore “X” Higher Capacity And Unique Extension Frames Cut Costs From Job Start To Finish

Fewer Tower Needed

Extra carrying capacity for SHORE “X” (11,000 lbs./leg, 44,000 lbs./tower) lowers labor costs by reducing the number of towers to be erected and dismantled.

Fewer Types and Sizes of Components

Costs of sorting and juggling inventories of odd sized frames and crosses from one use to the next is eliminated. Costly errors are reduced. Towers of any height can be erected using only one size base frame and an extension frame. The number and type of components are reduced by 20% or more on many projects.

Cuts Erection Costs

The simplicity of the system reduces confusion and supervision, speeds erection, and cuts costs. Easily adjusted screwjacks speed the grading of the decks. Self stabilizing towers need no supplementary bracing on normal shoring heights, further reducing costs. Small crews quickly erect the towers without the need for cranes or other mechanical equipment.

Lowers Stripping Costs

The shoring can be quickly released by a few turns of the screwjack handles. The towers provide a convenient work platform for the orderly removal of decking materials, allowing them to be quickly cleaned and stacked for the next use. Dismantling of the towers takes less than half the erection time. Many times the towers can be rolled to the next use without dismantling.

Reduces Cartage Costs

Lower trucking costs result from the need for fewer towers and the lower number of types and sizes of components. One truckload of steel falsework will do the work of four or five truckloads of wood posts.

These Simple Parts Erect Quickly And Easily

A Base Frames (HX 46, 4' x 6' or HX 25, 2' x 5') have carrying capacity of 11,000 pounds safe working load per leg (44,000 pounds per tower) because of the exclusive “X” brace frame design. Holes in legs in 12” increments receive Adapter Pins for supports of Extension Frame, providing infinite adjustment in conjunction with screwjacks.

B Extension Frames (HX 45, 4' x 5'4” or HX 24, 2' x 4'4”) telescope into Base Frames to give height adjustment of 1ft., 2ft., 3ft., 4ft., and 5ft. This adjustability eliminates the need for odd sized Frames and Crosses. Regardless of the extension height, Extension Frames are fully braced from the top of the Extension Frame to the Adapter Pin with one size Cross Brace.

C Adapter Pins fit into holes on legs of Base Frames, supporting the Extension Frames at the desired height and provide attachment points for Cross Braces.

D Adjusting Screwjacks with swivel plates compensate for uneven ground without wedging. Provides easy 12” height adjustments. Screwjacks can be used with Extension Frames by removing the cap at the top of the jack. The cap, combined with the collar on the jack handle, provides positive alignment of the Base Frame legs. Screwjacks have acme threads that allows easy adjustment and resist job abuse

E Super Locks provide fast, trouble-free attachment of cross bracing. Their heavy duty, welded construction withstands normal job abuse.

F Coupling Pins provide alignment of Base Frame and can be bolted through holes in legs of Base Frames for added safety and to permit hoisting assembled towers. Heavy duty Pigtailed (SPTP) or Drop Pins (SDP) may also be used for locking frames.

G Cross Braces attach easily and are ruggedly constructed.

H Base Plates (7” x 7” x 3/8”) distribute loads to sills or pads.

I Screwjacks with fixed Base Plates and Caps give easy 15” height adjustment.

J “U” Headed Screwjacks give easy 15” height adjustment. Ruggedly constructed heads (4” x 8”, 4” x 14”, 8” x 8”) provide convenient, heavy duty saddles for placement of timbers or beams.

K W 8 x 10 Steel Beams are easily handled.

L Junior Beam Clamps secure the beam to the “U” head to minimize the possibility of beam rotation.

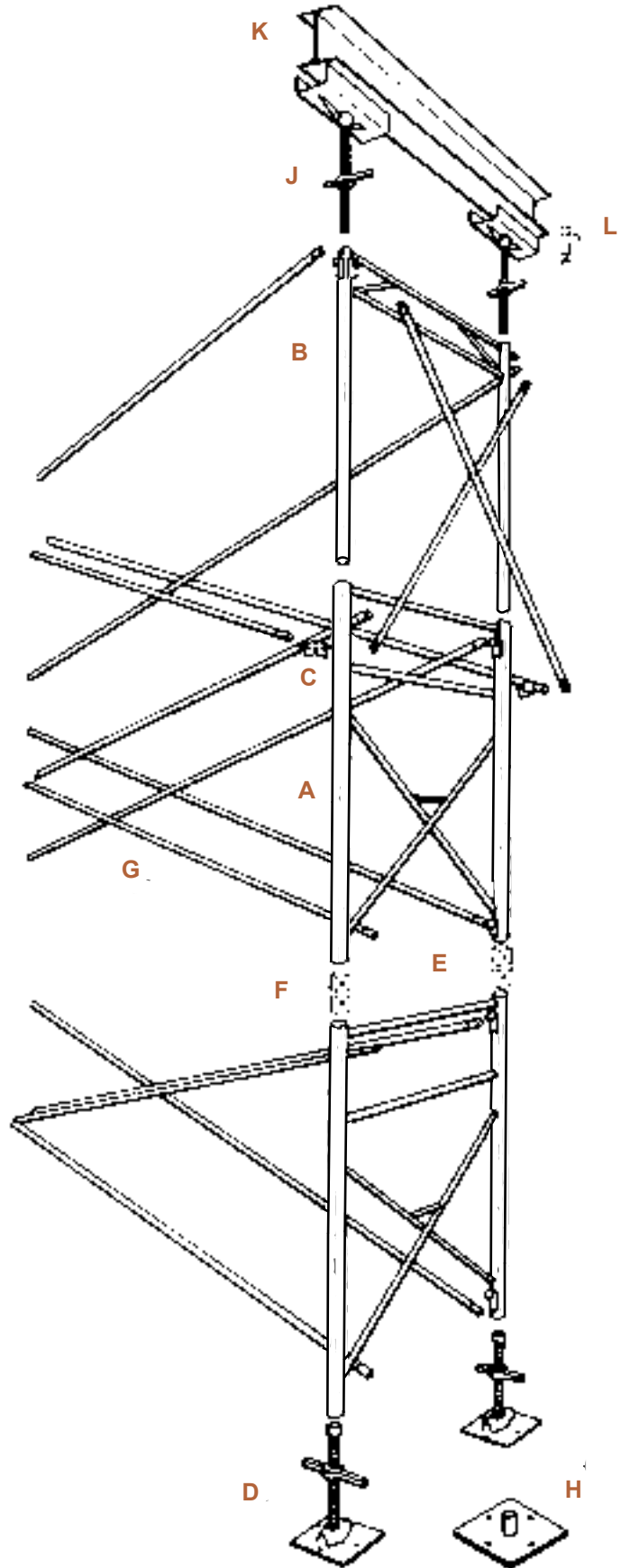
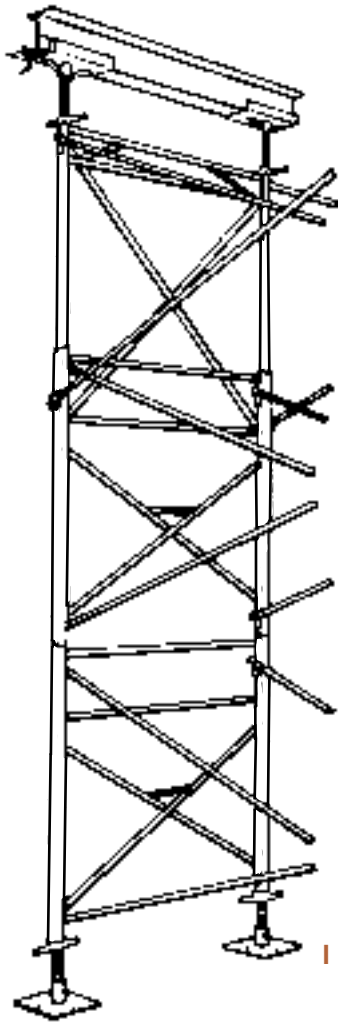

ADAPTER PINS



C

SUPER LOCKS



E

SHORE "X"

Typical Commercial Layouts

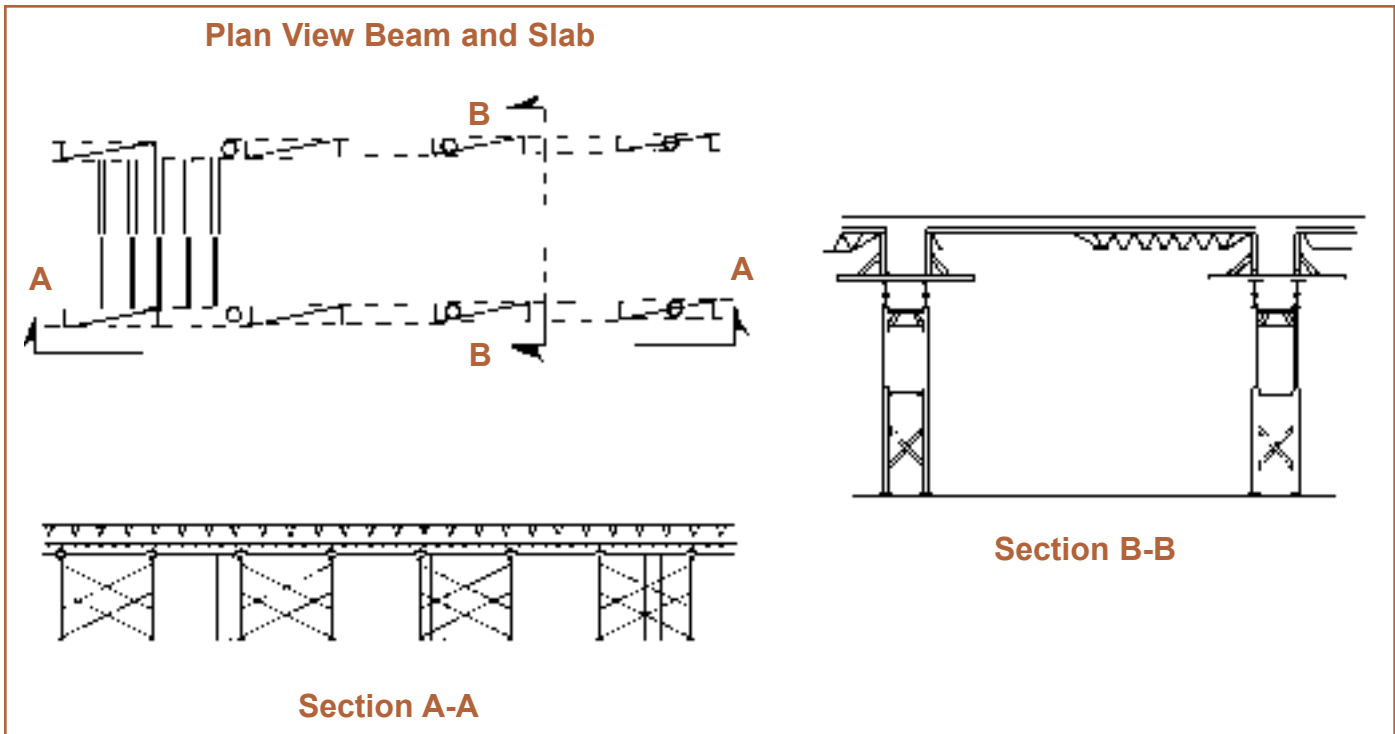

Beam and Slab

Each SHORE "X" tower replaces up to 14 posts and is self-stabilizing, requiring no auxiliary bracing between towers under 16 feet in height on 4' wide equipment (8' in height on 2' wide). These features enable the contractor to achieve substantial savings in time and labor. With SHORE "X" the contractor can choose frames either 2 or 4 feet wide. Two foot wide frames are generally used under beams up to 24 inches wide with shoring heights below 12 feet.

The 4 foot wide frames, affording greater stability, are used on wider beams and on shoring elevations over 12 feet. With either width frame, the stringers run past the columns allowing towers to be spaced for maximum loading.

On most installations, towers are spaced under the beams with the horizontal beams or wood joists being supported by the beam sides. Steel W 8 x 10 beams can be used as stringers to support the beam soffits--making it unnecessary for the contractor to furnish timber stringers

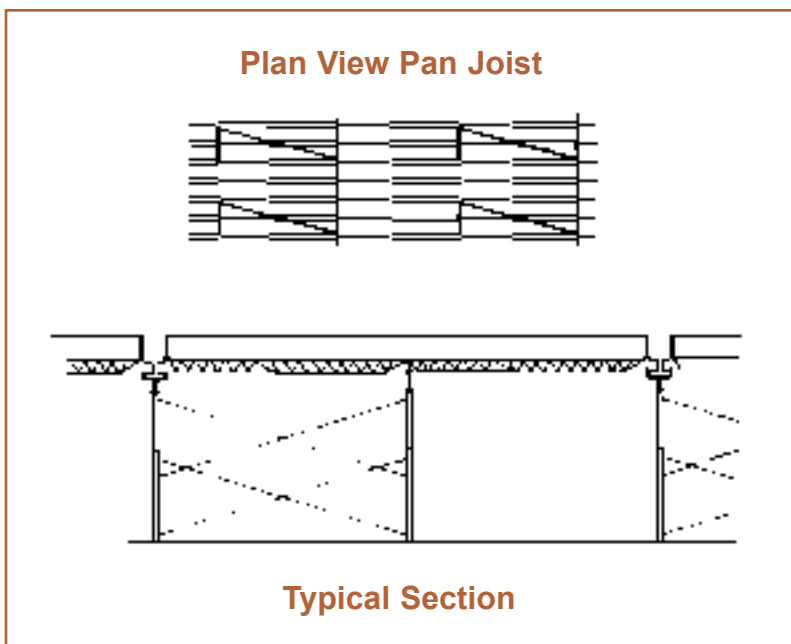

Pan Joists

Tower layouts on pan joist projects are essentially similar to those used on beam and slab jobs. The SHORE "X" system is particularly adaptable to pan joist construction because the opening spacing of the towers give full access, under the deck, for removal of pans and horizontal beams.

As required, the SHORE "X" towers may remain in position for re-shoring purposes, provided the re-shoring has been properly engineered.

Plan View Flat Slab and Drop Head

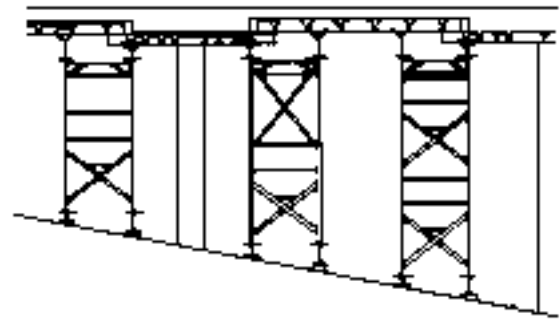
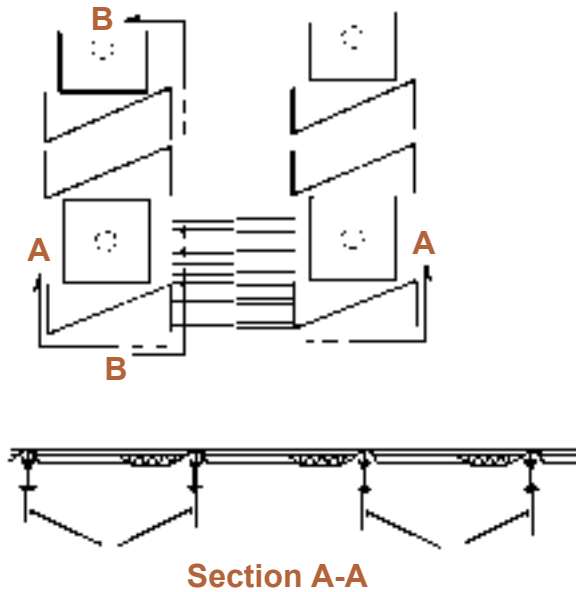

Section B-B

Flat Slab With Drop Head

Only 8 legs--two easily erected towers--provide all the support required for the typical bay found with flat slab and drop head construction.

Extra height adjustments, caused by the drop heads, are easily handled with the Extension Frame and Screwjack.

On many jobs, complete tower assemblies can be rolled from one position to another without dismantling. The SHORE "X" Rolling Dolly, used to relocate the towers, is extremely simple to operate and low in cost.

Note: End crosses are used when Extension Frames are extended 4 or 5 feet (See second tower, illustrated in Section B-B). Side crosses are used to brace Extension Frames at all levels of adjustment. Placement of the Side Crosses assures that the Adapter Pin is properly positioned to carry the Extension Frame. Horizontal or diagonal bracing between towers is normally used on towers 4 frames or more in height.

Flat Slab

SHORE "X" towers are spaced so that maximum use is made of the extra carrying capacity of the SHORE "X" system--resulting in the need for a minimum number of towers. The steel W 8 x 10 beams assure adequate carrying capacity to transmit the loads safely to the towers.

This combination of SHORE "X" and horizontal beams provides the most efficient method yet devised for shoring a flat slab job.

These features have enabled contractors to shore flat slab and drop head jobs with remarkable savings in time and labor.

Plan View Flat Slab

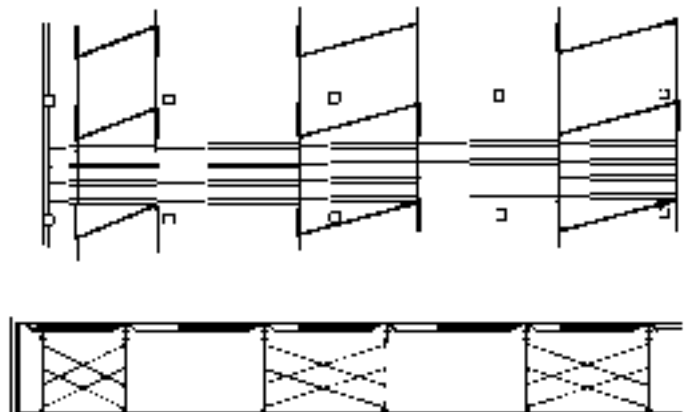

Typical Section

SHORE "X"

Engineering Your Shore "X" Jobs

Two features of the SHORE "X" system materially reduce engineering costs: (1) the 11,000 lbs. per leg carrying capacity, and (2) the 1 foot to 7 foot height adjustments provided by the Extension Frames and Screwjacks. As a result, contractor shoring estimates are simplified and more accurate. In addition, the extra carrying capacity and height flexibility speed up the preparation of layouts for field use.

Field engineers can quickly check erected towers and make last minute changes on elevation by adjusting Extension Frames or Screwjacks--without dismantling the tower.

SHORE "X" engineers will help you estimate, design and schedule your falsework requirements. These services are available to help SHORE "X" customers achieve the most profitable results from the use of SHORE "X" equipment.

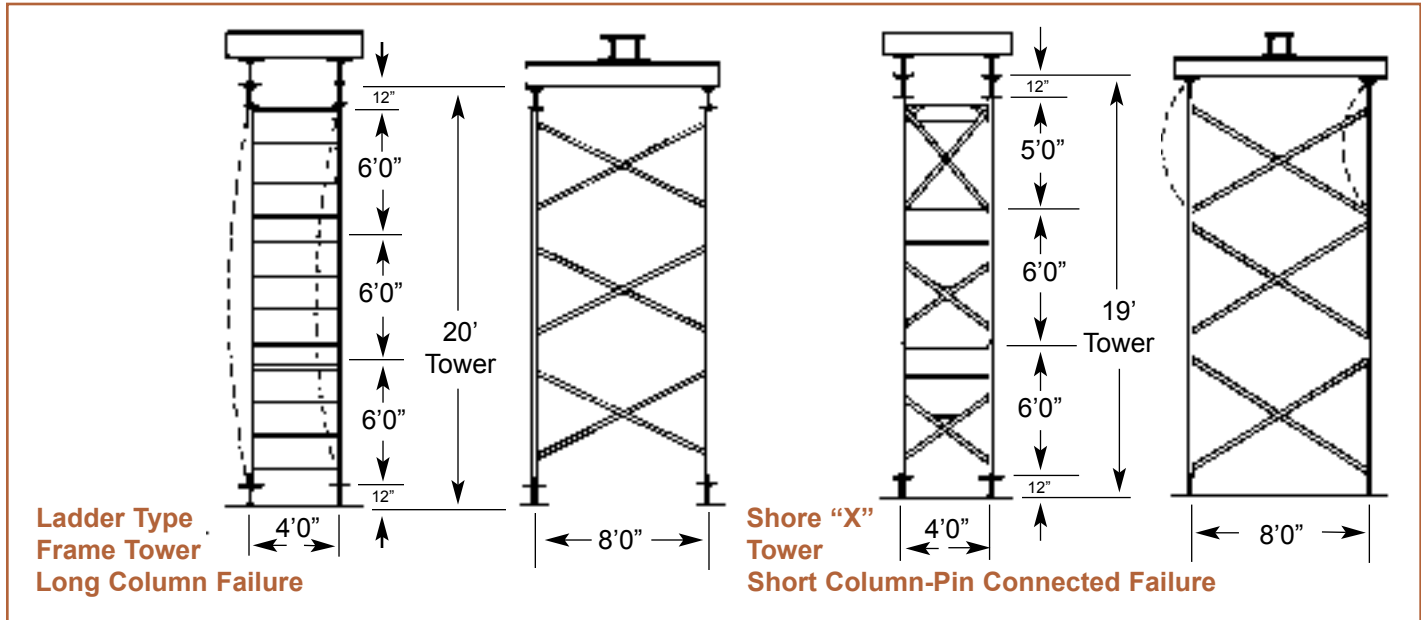

Shore "X" Test Results: Summary

Ladder Frame Towers

(with fixed base screwjacks top and bottom)

Leg Tubing 2.375" O.D. x .154" Wall. Ultimate Load per Leg--25,000 lbs.

Safe Working Load per Leg--10,000 lbs.
(40,000 lbs. per tower)

Shore "X" Towers

(with fixed base screwjacks top and bottom)

Base Frame Leg Tubing--2.375" O.D. x .154" Wall

Extension Frame Leg--1.90" O.D. x .190" Wall

Ultimate Load per Leg--27,500 lbs.

Safe Working Load per Leg--11,000 lbs.
(44,000 lbs. per tower)

Extensive tests have been conducted on the carrying capacity of SHORE "X" towers and on ladder type frame shoring towers. The tests prove conclusively that the towers with X-Braced frames are capable of supporting higher loads than towers using ladder frames.

Further, the X-Brace significantly increases the frame's ability to withstand horizontal loads such as imparted during concrete pours or by equipment moving over the shored areas prior to or during pours.

The tests illustrated were made with towers three frames high using *fixed base* screwjacks with 12" adjustment at the top and bottom of the tower. Each tower tested was free standing with loads applied as illustrated.

Tubing of the scaffold frames is made from high-strength material with tensile strengths of 70,000 psi and yield strengths of 50,000 psi. The recommended safe working load (based on the 2 1/2:1 safety factor recommended by the Scaffolding, Shoring & Forming Institute) for Shore "X" towers using screwjack, with caps and base plates, is 11,000 lbs. per leg, 44,000 lbs. per tower.

Similar tests were conducted using towers with *swivel base* screwjacks extended 12" at the top and bottom of the tower. SHORE "X" towers tested in this manner supported slightly lower loads than towers with fixed base plates; significantly lower in the case of ladder frame towers. Swivel base screwjacks eliminate the need for wedging to meet sloping deck conditions and avoid the introduction of eccentric loading when towers are placed on uneven pads or sills. The recommended safe working load for SHORE "X" towers using swivel base screwjacks is 10,000 lbs. per leg, 40,000 lbs. per tower.

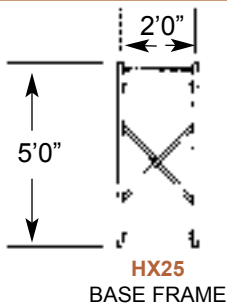
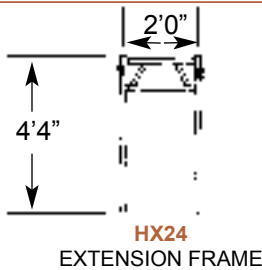
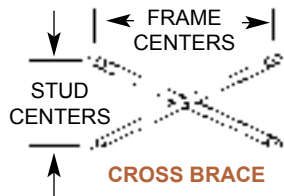
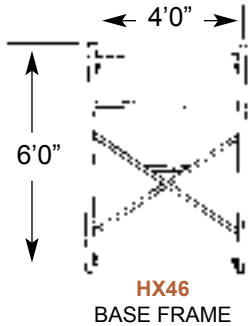
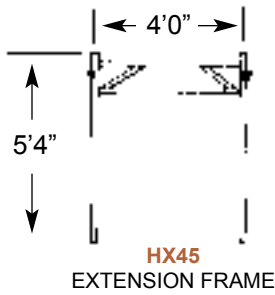

TOP JACK COMBINATIONS

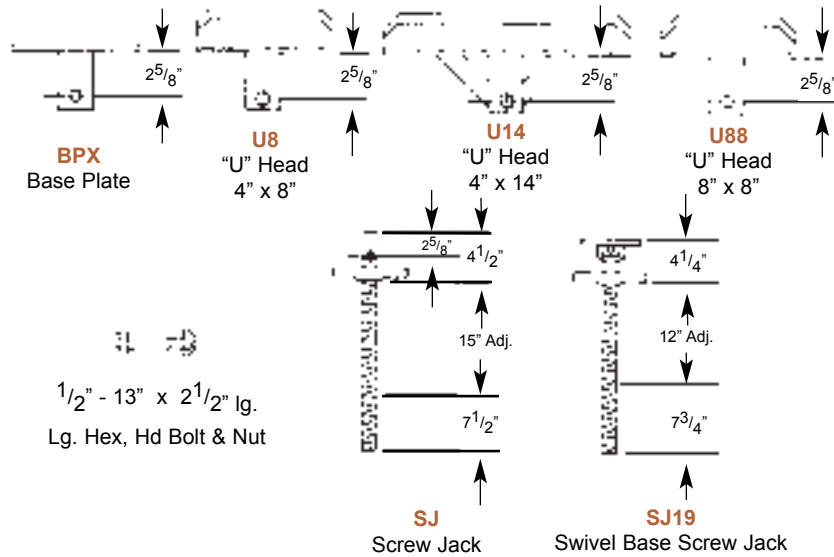

BOTTOM JACK COMBINATIONS

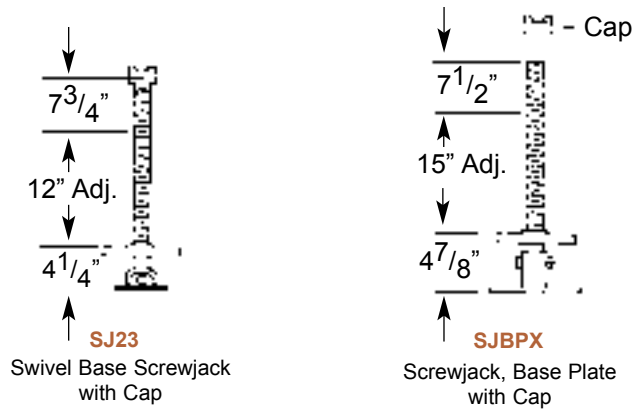

Deep Cut Acme Threaded Jacks are heat treated to give greater strength and resistance to job abuse.

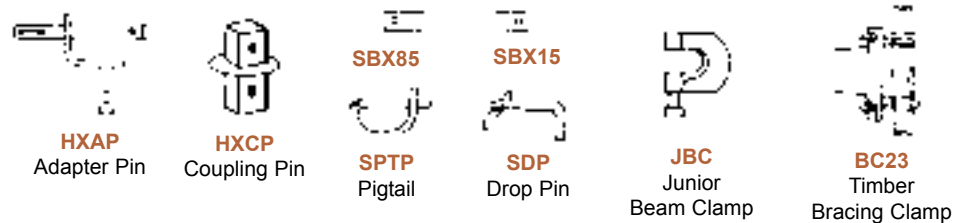

Components Required for Typical Tower Assembly

4' Wide Commercial Towers

Tower Description	HX46	HX45	HXAP	HXCP	B45 (B54)	B105	BPX	SJU14 *SJU14C	BC23	WEIGHT LBS.
4' x 10' Towers with BPX on bottom & 4" x 14" "U" Head Screwjacks on top. 2 Frame Tower										
1 BF	6'5" to 7'8"	2	---	---	---	2	4	4*	---	308
1 BF & E	7'5" to 12'8"	2	2	4	---	2	4	4	---	474
2 BF	12'5" to 13'8"	4	---	---	---	4	4	4*	---	484
2 BF & E	13'5" to 18'8"	4	2	4	4	2	6	4	---	650
3 BF	18'5" to 19'8"	6	---	---	---	---	6	4	4*	---
3 BF & E	19'5" to 24'8"	6	2	4	8	2	8	4	4	830
4 BF	24'5" to 25'8"	8	---	---	---	---	8	4	4*	840
4 BF & E	25'5" to 30'8"	8	2	4	12	2	10	4	4	1010
Extra BF	6'	2	---	---	---	2	---	---	---	184

2' Wide Commercial Towers

Tower Description	HX25	HX24	HXAP	HXCP	B104	BPX	SJU14 *SJU14C	BC23	WEIGHT LBS.	
2' x 10' Towers with BPX on bottom & 4" x 14" "U" Head Screwjacks on top. 2 Frame Tower										
1 BF	5'5" to 6'8"	2	---	---	---	2	4	4*	---	255
1 BF & E	6'5" to 10'8"	2	2	4	---	4	4	4	---	376
2 BF	10'5" to 11'8"	4	---	---	---	4	4	4*	---	398
2 BF & E	1'5" to 15'8"	4	2	4	4	6	4	4	2	509
Extra BF	5'	2	---	---	---	4	2	---	---	135

SHORING FOR CONCRETE FORMWORK

SHORING SAFETY IS EVERYONE'S RESPONSIBILITY!

Everyone's safety depends upon the proper erection and safe use of shoring. Inspect your shoring before each use to see that the assembly has not been altered and is safe for your use.

POST THESE SHORING SAFETY RULES in a conspicuous place and be sure that all persons who erect, use, or dismantle shoring are aware of them.

FOLLOW ALL STATE, LOCAL AND FEDERAL CODES, ORDINANCES AND REGULATIONS pertaining to Shoring.

INSPECT ALL EQUIPMENT BEFORE USING. Never use any equipment that is damaged, severely rusted, or is missing locking devices. Any component which cannot be brought into proper alignment or contact with the component into or onto which it is intended to fit shall be removed and replaced.

A SHORING LAYOUT shall be available and used on the job-site at all times.

INSPECT ERECTED SHORING AND FORMING FOR CONFORMITY WITH LAYOUT AND SAFETY PRACTICES PRIOR TO POUR, DURING POUR, AND AFTER POUR UNTIL CONCRETE IS SET.

CONSULT YOUR SAFWAY REPRESENTATIVE WHEN IN DOUBT. Shoring is our business. NEVER TAKE CHANCES.



WARNING

SERIOUS INJURY OR DEATH CAN RESULT FROM YOUR FAILURE TO FAMILIARIZE YOURSELF AND COMPLY WITH ALL APPLICABLE SAFETY REQUIREMENTS OF FEDERAL, STATE AND LOCAL REGULATIONS. UNDERSTAND THESE SAFETY GUIDELINES BEFORE ERECTING, USING, OR DISMANTLING THIS SHORING.

I. PRIOR TO THE POUR

A. GENERAL

- USE SAFWAY'S RECOMMENDED SAFE WORKING LOADS AND PROCEDURES FOR:
 - Span, spacing, and types of shoring members.
 - Types, sizes, heights, and spacing of vertical shoring supports.
- USE LUMBER EQUIVALENT TO THE STRESS, species, grade and size specified on the layout. Use only lumber that is in good condition. Do not splice timber members between their supports.
- PROVIDE PROPER FOUNDATION (sills, beams, or cribbing) below base plates for the distribution of leg loads to concrete slabs or ground. Existing ground shall be level and thoroughly compact prior to erection of shoring to prevent settlement. Consideration must be given to potential adverse weather conditions throughout the pour cycle such as washouts, freezing and thawing of ground, etc. Consult a qualified soils engineer to determine the proper size foundation required for existing ground conditions.
- DO NOT MAKE UNAUTHORIZED CHANGES OR SUBSTITUTION OF EQUIPMENT; always consult your Safway supplier prior to making changes necessitated by jobsite conditions.
- PROVIDE GUARDRAIL SYSTEMS ON ALL OPEN SIDES AND OPENINGS IN FORMWORK AND SLABS.
- ACCESS MUST BE PROVIDED TO ALL FORMING DECK LEVELS. If it is not available from the structure, access ladders or stair towers must be provided. Access ladders must extend at least three (3) feet above formwork.



WARNING

FALL ARREST equipment attached to shoring MAY NOT prevent serious INJURY or DEATH if a fall occurs

- IF MOTORIZED CONCRETE PLACEMENT EQUIPMENT IS TO BE USED, be sure that lateral loads, vibration, and other forces have been considered and adequate precautions taken to assure stability.
- PLAN CONCRETE POURING METHODS AND SEQUENCES TO insure against unbalanced loading of the shoring equipment. Take all necessary precautions to avoid uplift of shoring components and formwork.
- FASTEN ALL BRACES SECURELY.
- CHECK TO SEE THAT ALL CLAMPS, SCREWS, PINS and all other components are in a CLOSED OR ENGAGED POSITION.
- MAKE CERTAIN THAT ALL BASE PLATES AND SHORE HEADS ARE IN FIRM CONTACT WITH THE FOUNDATION AND FORMING MATERIAL.
- USE SPECIAL PRECAUTIONS when shoring to or from sloped surfaces.
- AVOID ECCENTRIC LOADS ON U-HEADS, AND TOP PLATES by centering stringers on these members.
- AVOID SHOCK OR IMPACT LOADS for which the shoring was not designed.
- DO NOT PLACE ADDITIONAL TEMPORARY LOADS (such as rebar bundles) on erected formwork or poured slabs, without checking the capacity of the shoring and/or structure to safely support such additional loads.
- The completed shoring setup shall have the specified bracing to give it lateral stability.
- The erection of shoring should be under the supervision of an experienced and competent person.

B. FRAME SHORING

- FOLLOW THE SHORING LAYOUT DRAWING AND DO NOT OMIT REQUIRED COMPONENTS.
- DO NOT EXCEED THE SHORE FRAME SPACINGS OR TOWER HEIGHTS as shown on the shoring layout.
- SHORING LOAD MUST BE CARRIED ON ALL LEGS.
- PLUMB AND LEVEL ALL SHORING FRAMES as the erection proceeds, and check plumb and level of shoring towers just prior to pour.
- DO NOT FORCE braces on frames to fit - level the shoring towers until proper fit can be made easily.
- TIE HIGH TOWERS OF SHORING FRAMES TOGETHER with sufficient braces to make a rigid, solid unit (consult your Safway representative for recommendations). Shoring must always be secured when the height of the shoring towers exceed four (4) times the minimum base width. See NOTE 1.
- EXERCISE CAUTION in erecting or dismantling free standing shoring towers to prevent tipping.
- DO NOT CLIMB CROSS BRACES.

C. SCREWJACKS

- USE SCREWJACKS to adjust for uneven grade conditions, to level and accurately position the falsework and for easy stripping.
- DO NOT EXCEED SAFWAY'S RECOMMENDED MAXIMUM EXTENSION OF SCREWJACKS. Keep screwjack extensions to a minimum for maximum load carrying capacity.
- MAKE CERTAIN THAT ALL SCREWJACKS are firmly in contact with the foundation and frame legs.

D. POST SHORING

- PLUMB ALL POST SHORES AS THE ERECTION PROCEEDS. Check plumb of post shores just prior to pour.
- POST SHORES MAY REQUIRE ADDITIONAL STABILITY BRACING. Refer to manufacturer's instruction. Required bracing shall be installed as the shores are being erected.
- DEVICES WHICH ATTACH THE EXTERNAL LATERAL STABILITY BRACING shall be securely fastened to each post shore to be shored.
- POST SHORES MORE THAN ONE TIER HIGH SHOULD NOT BE USED. Where greater shore heights are required consult your Safway supplier.

E. HORIZONTAL SHORING

1. SPECIAL CONSIDERATION MUST BE GIVEN TO THE INSTALLATION OF HORIZONTAL SHORING:
 - a) When sloped or supported by sloping ledgers (stringers).
 - b) When ledger (stringer) height/width ratio exceeds 2.5 to 1. Under no circumstances shall horizontal shoring beams bear on a single "two-by" ledger (stringer).
 - c) When eccentric loading conditions exist.
 - d) When ledger (stringer) consists of multiple members (i.e., double 2x6, 2x8, etc.)
 - e) When horizontal shores are placed other than at right angles to their supports.
2. ASSURE THAT BEARING ENDS OF SHORING BEAMS ARE PROPERLY SUPPORTED and that locking devices are properly engaged before placing any load on beams.
3. HORIZONTAL SHORING BEAMS SHOULD NOT be supported other than at the bearing prongs unless recommended by your Safway supplier. Cantilever "male end" of Safway horizontal beams only. Cantilever shall not exceed 24.
4. DO NOT NAIL BEAM BEARING ENDS TO LEDGER.
5. PROVIDE AND MAINTAIN ADEQUATE SUPPORT to properly distribute shoring loads. When supporting horizontal shoring beams on:
 - a) MASONRY WALL - Insure that masonry units have adequate strength. Brace walls as necessary.
 - b) LEDGERS - supported by walls using bolts, or other means, should be properly designed and installed per recommendation of supplier or job architect/engineer.
 - c) FORMWORK - Shoring beams should be designed for the additional loads imposed by the formwork.
 - d) STRUCTURAL STEEL FRAMEWORK - The ability of the steel to support all loading should be checked and approved by the responsible project architect/engineer.
 - e) STEEL HANGERS - be sure the bearing ends fully engage on the hangers. The hangers shall be designed to confirm to the bearing end and shall have a rated strength to safely support the shoring loads imposed. Hangers must be plate saddle rather than wire type. Check with manufacturer of hangers for specific application. (Follow hanger manufacturers' recommendations.)

F. FINAL INSPECTION

Be sure that:

1. There is a sound foundation under every leg.
2. All base plates and screwjacks are in firm contact with foundation.
3. Every component (including exterior bracing) agrees with the shoring layout as to type, span, number, location, and size.
4. All shore pins are properly installed and fully seated.
5. All frames are plumb and braced to form towers and/or all posts are plumb and braced as required by user instructions.
6. All formwork follows forming layout and horizontal beams fully bear on their supports.
7. All clamps, screws, pins and other fasteners (including locking devices on adjustable beams) are closed, tightened, or engaged.

II. DURING THE POUR

1. ADJUSTMENT OF SHORING AND/OR POST SHORES TO RAISE FORMWORK shall not be made once the pour begins.
2. INSURE POUR SEQUENCE will not cause an unbalanced load on shoring equipment.
3. Monitor possible movement of shoring components when placing concrete.



WARNING

Do not position workers below formwork while concrete is being placed

III. REMOVAL

Loaded shoring equipment shall not be released or removed, including cross braces, until the approval of a qualified engineer has been received. Premature releasing or stripping of forms can cause failure. A qualified engineer must decide when and how stripping is to proceed. Weather conditions, variations in different parts of the structure and the setting qualities of the concrete all affect the stripping process.

IV. RESHORING

1. Reshoring is one of the most critical operations in formwork; consequently, reshoring procedure must be designed and planned in advance by a qualified structural engineer and approved by the project architect/engineer.
2. Slabs or beams which are to be reshored should be allowed to take their permanent deflection before final adjustment of reshoring equipment is made.
3. The reshoring shall be thoroughly checked by the architect/engineer to determine that it is properly placed and that it has the allowable load capacity to support the areas that are being reshored.
4. Equipment to be left in position for reshoring should be checked thoroughly by a qualified engineer. Horizontal shoring should never be used as a part of reshoring system. Extreme care must be taken to release the adjustment screws to a point where the slab takes its permanent deflection. The adjustment screws should then be tightened until contact is again made with the underside of the slab. In this manner the frame reshoring below will not be carrying the load of the slab that it had previously shored.

Note 1:

California and some other states require a height-to-minimum base width ratio of three to one (3:1). Refer to the governing codes for your job location

Note 2:

ADDITIONAL INSTRUCTIONS AND INFORMATION ARE AVAILABLE FROM SAFWAY STEEL PRODUCTS INC. REGARDING:

**VIDEOS
ASSEMBLY**

**LOAD CAPACITY
BRACING & TYING
PARTS IDENTIFICATION
ERECTION PROCEDURES
ENGINEERING ASSISTANCE**

**ACCESS
WEIGHTS
TRAINING
PLANKING
SAFETY TIPS
DISASSEMBLY
WALLET CARD**

The Complete Safway Line

- Sectional Scaffold
- Systems™ Scaffold
- Tube & Clamp Scaffold
- Safway SL Frame System™
- Power Swings
- Rolling Towers
- Shoring
- Scaffold Training

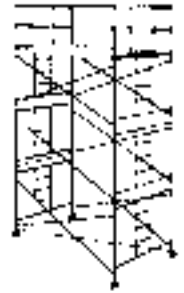
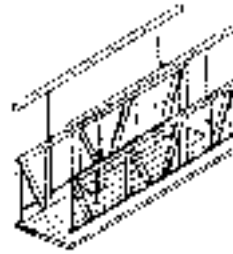
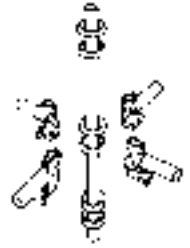
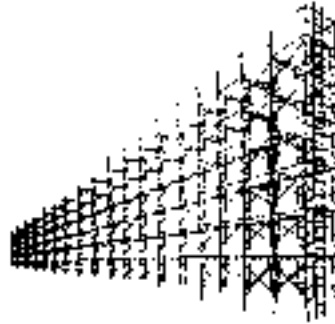

All drawings in this brochure are for illustrative purposes only.

This brochure is intended for general information only. Because of the many variables which affect the performance of this product line, some of the information in this brochure may not apply. For specific applications, contact Safway.

Note: Erection, use, maintenance and disassembly must conform to current Safway instructions as well as ALL federal, state and local regulations. Copies of complete safety guidelines for these and other products are available from Safway or your Safway Dealer without charge.

DISTRIBUTED BY



SAFWAY SERVICES, INC.

N19 W24200 Riverwood Drive
Waukesha, WI 53188
(800) 558-4772 ■ (262) 523-6500
Fax: (262) 523-9808

www.safway.com